

Compost Bedded Pack Barn Design

Features and Management Considerations

Jeffrey Bewley, Animal and Food Sciences, Joe Taraba and George Day, Biosystems and Agricultural Engineering, Randi Black, Animal and Food Sciences and Flavio Damasceno, Biosystems and Agricultural Engineering

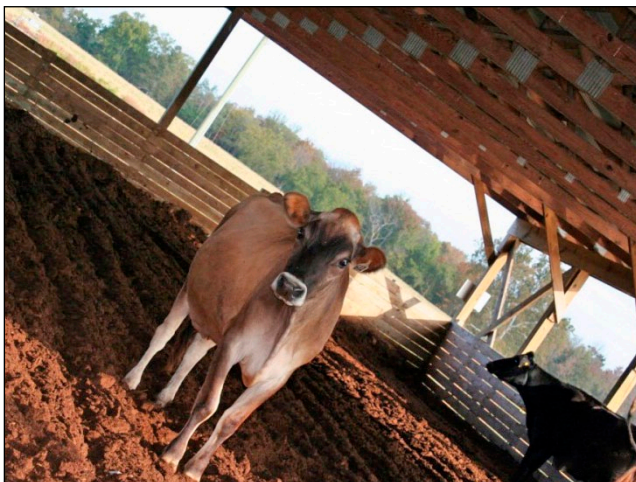

Introduction

The compost bedded pack barn is a housing system for lactating dairy cows. It consists of a large, open resting area, usually bedded with sawdust or dry, fine wood shavings and manure composted into place and mechanically stirred on a regular basis. The most critical success factor for managing a compost bedded pack barn is providing a comfortable, dry resting surface for lactating cows at all times. Producer-reported benefits of these barns include improved cow comfort (Figure 1), improved cow cleanliness (Figure 2), low maintenance, improved feet and legs, decreased somatic cell count, increased heat detection (Figure 3), ease of manure handling, increased production, increased longevity, low investment costs, less odor, fewer flies, less concern with cow size (Figure 4), and improved manure value.

The general concept of composting is mixing a carbon source (bedding) with organic material high in nitrogen (manure/urine), while providing conditions (porosity) to encourage air infiltration into the pack, and maintaining

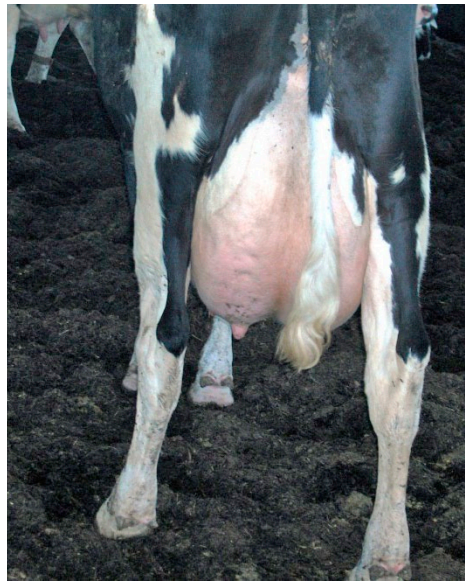

Figure 2. When managed properly, compost bedded pack barns provide a dry resting surface for cows, resulting in clean cows and udders.



Figure 1. Compared to freestall barns, cows have more freedom of movement in the compost bedded pack barn and can lie down and get up more naturally.

the moisture level to achieve rapid breakdown of organic matter. It is important to note that composting within a barn where manure, urine, and bedding are continuously added results in compost at cleanout that is not completely finished or cured.

Compost bedded pack barns can be the primary housing in smaller herds or provide special needs housing in larger herds. Cows can be managed in a single group within the barn or in multiple groups subdivided within the barn.

Keeping the top layer of bedding dry is the most important part of managing a compost bedded pack barn. Proper composting increases the bedding temperature

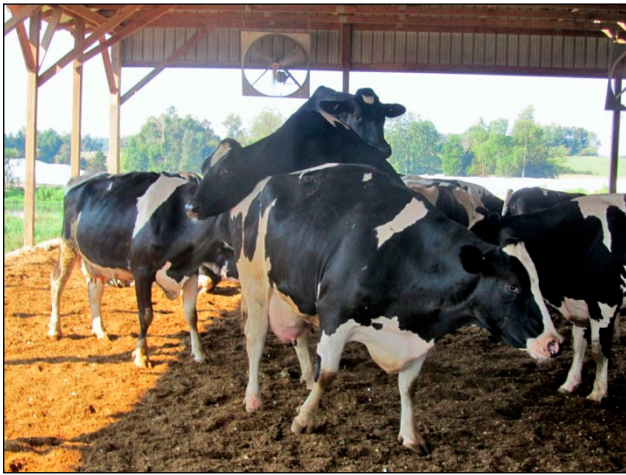

Figure 3. Cows exhibit heat well because of improved footing compared to barns with concrete floors.



Figure 4. Cows of different breeds and sizes can be housed together easily in a compost bedded pack barn.

and decreases the bedding moisture by increasing the drying rate. The pack is stirred at least two times per day. Stirring is typically accomplished while the cows are being milked, using various types of cultivators or roto-tillers. Facility design; ventilation; timely addition of fresh, dry bedding; frequent and deep stirring; and avoidance of overcrowding are the keys to a good working compost bedded pack barn. Poor management and poor coordination may lead to very undesirable compost bed conditions, dirty cows, elevated somatic cell counts, and increased clinical mastitis incidents (Figure 5).

Site Selection and Preparation

As with any dairy facility, site selection is critical. To maximize natural ventilation, the barn should be located to take advantage of prevailing summer winds and the sun. Care should be taken to ensure that the

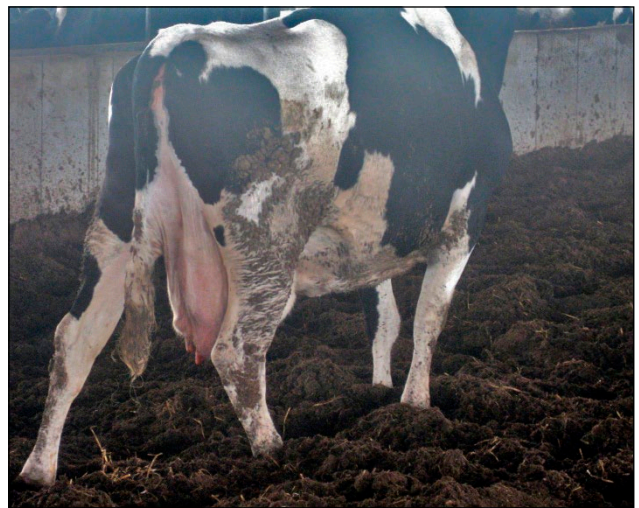

Figure 5. Wet resting surfaces increase the incidence of dirty cows, mastitis, hairy heel warts, and elevated somatic cell counts.

barn is placed far enough away from other barns, silos, or buildings (Figure 6).

Barn ventilation must allow for fresh air, since the composting pack generates additional heat and moisture that must escape from the barn. This is especially important in the summer.

The building site should be elevated slightly so that exterior surface drainage is diverted around and away from the building to minimize rain and snow runoff infiltrating the pack.

Although it is unlikely the pack will be wet enough for drainage from the bottom, selecting a location with minimal potential for environmental risk from pack seepage is also important. Seepage should be minimal if the pack's optimum operating moisture content of 45 to 55 percent is maintained. This moisture level is well below the typical water holding capacity of a properly functioning compost bedded pack barn (about 72 percent).

Building sites that require excavation or cuts into slopes may expose groundwater sources to the building, especially during wet periods. The emergence of water under the compost bed will be a problem that contributes to higher moisture levels. Drainage tile will be required to remove this water from the building site.

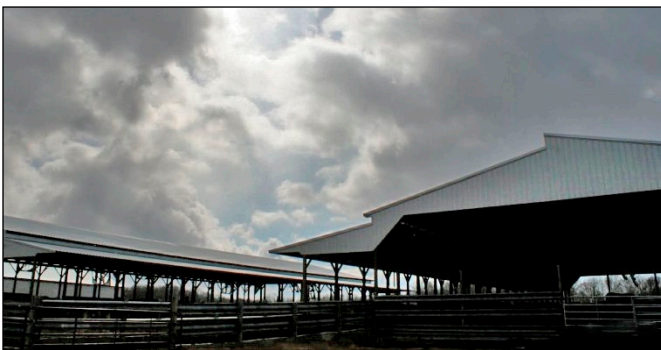

Figure 6 . These barns were constructed too close together. Neighboring barns should have at least 100 feet between them to maximize airflow.

The pack base should be either clay, gravel, or concrete. A concrete base has no real advantages, so new facilities are generally constructed using a clay base, which is potentially cheaper. Either concrete or clay can reduce seepage from the pack into the underlying soil. However, some states require concrete or the equivalent compacted base to prevent groundwater contamination. Check with the appropriate state agency during the building planning stage.

Layout

Most newly constructed compost bedded pack barns are built by modifying existing designs for two-, three-, or four-row freestall barns with wooden, steel, or hoop frames. Some producers have even built their barns with dimensions that allow flexibility for converting to a freestall barn later by adding concrete alleys, freestall platforms, dividers, and waterers. These modifications allow flexibility in case producers find the facility does not meet their needs or a changing market or bedding supply makes modifications necessary.

While a number of different barn designs exist, suggested layouts from the University of Wisconsin and University of Minnesota are depicted in Figures 7 and 8. These designs are a single building with sufficient sidewall openings and ridge vent width for proper ventilation (Figure 9). Hoop structures also have been used, although concerns exist about adequate ventilation in these structures (Figure 10).

The structure includes the compost bedded open resting area with a concrete alleyway for access to the feedbunk and waterers. The bedded pack is surrounded on all sides by 2- to 4-foot walls, including a wall to separate the bedded pack from the feed alley. This is helpful in managing pack moisture. Additionally on the outside



Figure 7 . Recommended layout with feed alley, feedbunk, waterers, retaining walls, walkways, and open resting area.

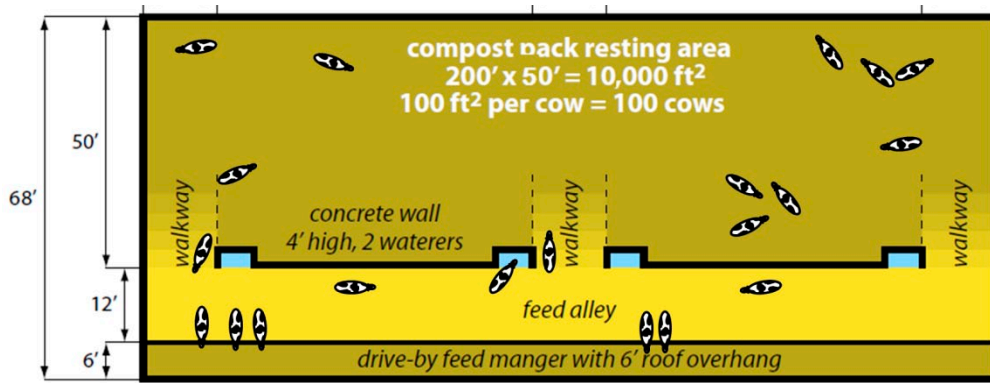

Figure 8. Compost barn layout for 100 cows. This layout has three walkways to access the pack, drive-by feeding, and 6-foot overhang. Waterers are against the concrete wall, separating the bedded pack from the feed alley. They are accessed only from the feed alley. Not drawn to scale.



Figure 9. These facilities demonstrate features of the optimal compost bedded pack barn including high open sidewalls, open ridge with a cap, retaining walls for manure storage, and at least 100 square feet of resting space per cow.

of the barn, the retaining wall keeps bedding material within the barn (Figures 11 and 12). These walls may be cast-in-place concrete, moveable concrete panels, highway guardrail, or wooden panels (Figure 13). Design walls considering the pressure from the manure pack. Wheeled equipment on the compost bed increases the wall design surcharge pressure. As the compost depth

rises, these walls no longer are barriers, and cow safety becomes a concern (Figure 14). Topping the barrier with wire fencing, steel cable, high-tension wire (a 4- to 6-inch board should be placed so the cow realizes a fence is there), bars or wood planking will eliminate this risk (Figure 15). Minimize fencing to avoid negative airflow implications.



Figure 10. A few producers have used hoop structures for compost barn housing.



Figure 11. A concrete retaining wall provides separation between the feed alley and the pack area.



Figure 12. Without a retaining wall or fence separating the pack area from the feed alley, managing moisture in this barn may be challenging.



Figure 13. Because the pack area serves a dual purpose of providing resting space for cows and storing manure, many producers build a retaining wall around the pack with either (A) cast-in-place concrete, (B) wood plank, or (C) highway guardrail. Other barns (D) have minimal to no separation between the pack area and the outside of the barn or feed alley. All designs can work well.



Figure 14. Compost bed depth can increase injury risks at the alleyway separation wall or along the bed perimeter.

Feed, Water, and Alleys

For optimum animal performance and health, feed and water should be easily accessible and available at all times. Feeding areas may be located in the barn or under a separate roof outside the barn. However, feeding areas in the barn are preferred to encourage more feed intake. If a separate feedbunk and waterer is utilized, cows will prefer resting over travel if the distances to them are greater than 300 feet. Producers should provide a minimum of 24 to 30 inches of feed bunk space per cow, 3 feet of water tank perimeter per 15 to 20 cows, and at least two separate water locations per pen. Producers should not reduce feed and water access in an effort to build a low-cost facility.

Concrete feed alleys should be 14 to 16 feet wide (Figure 16), with access to the bedded pack located every 50 feet and at each end (Figures 17 and 18). Cows will generally use the resting space more efficiently when they have multiple entry points along the long side of the rectangular resting area. If the entrance is narrow with only one entry point, a wet, dirty area may develop, because of the cow traffic. Additionally, cows are less likely to distribute themselves throughout the barn. The feed alley, located on one long side of the barn or on both sides of a drive-through barn, allows cows access to feed and water without traveling long distances (Figure 19). Fans and sprinklers placed along the feedbunk improve cow cooling and increase feed intake (Figure 20 and 21). Because cows defecate and urinate more around feed and water, they should have access to waterers only on the alley side. Alley-only access minimizes excess moisture in the pack and keeps water cleaner. It also eliminates the need to alter waterer height as the pack depth changes (Figures 22 through 24).



Figure 15. Barrier topper options include (A) steel cable, (B) pipe, (C) fence panel, (D) wood planking, and (E) highway guard rail.

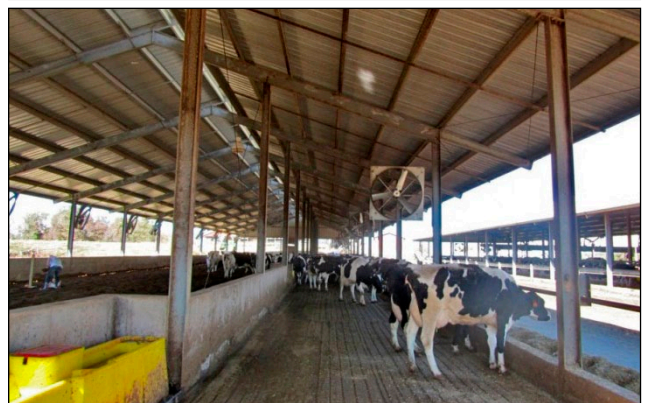
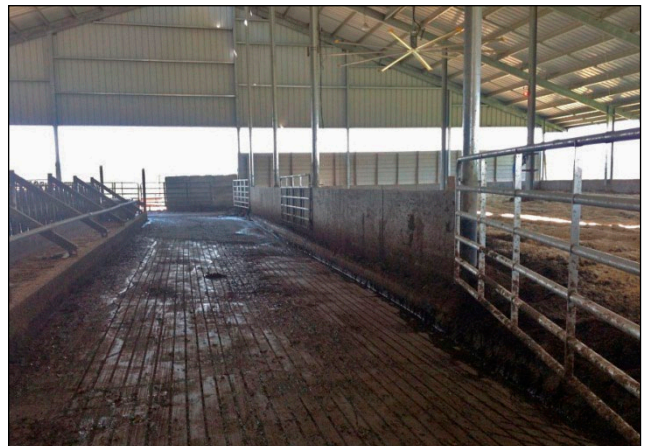
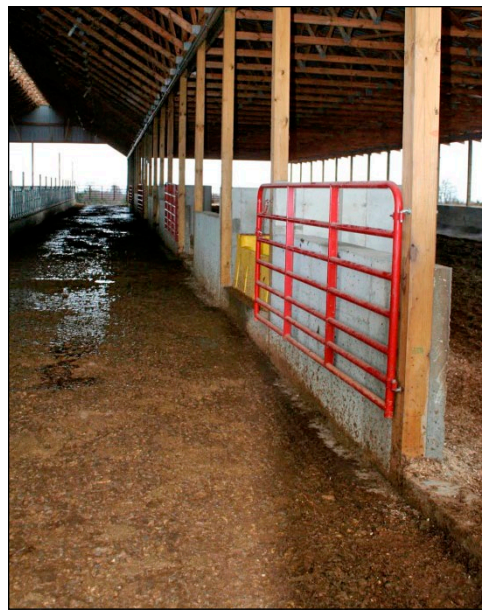

Figure 16. Wide alleys improve cow flow, minimize the risk of cow injury, and allow easy access to feed and water.

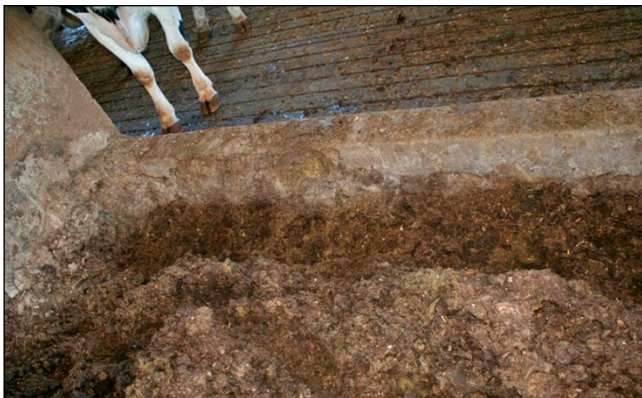
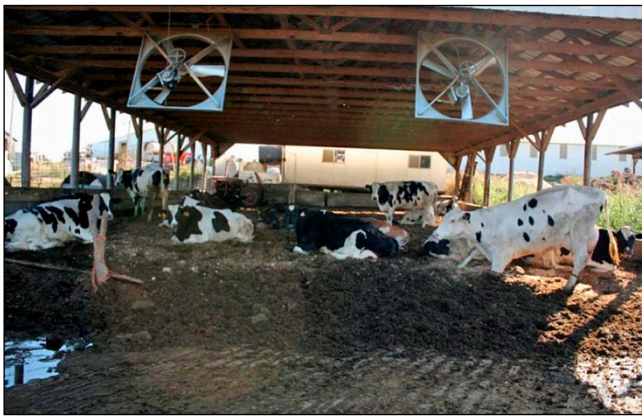
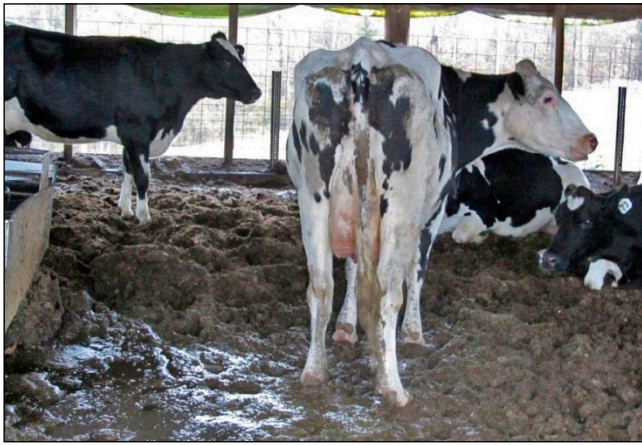

Figure 17. Entrances are always the wettest areas within the pack. Wide entrances increase the size of this wet area. Additionally, providing cows access to the pack from the short end of the barn may lead to a particularly wet area.



Figure 18. To minimize wetness, build multiple, narrow entrances along the long side of the barn. Entrances should be spaced every 50 feet.



A

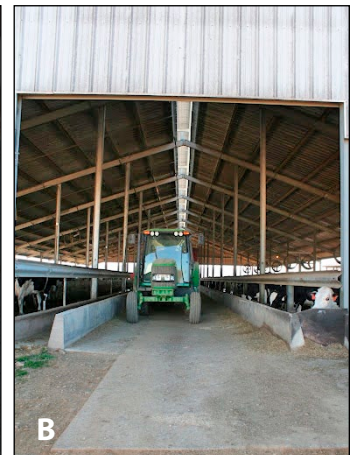

B



C

Figure 19. Drive-by or drive-through feedbunks may be used with (A) or without head locks (B and C).



Figure 20. Fans placed along the feedbunk are helpful for minimizing the effects of heat stress and increasing feed intake.



Figure 21. Sprinklers along the feedbunk, supplemented with fans, provide additional cow cooling benefits when the temperature humidity index exceeds 68.

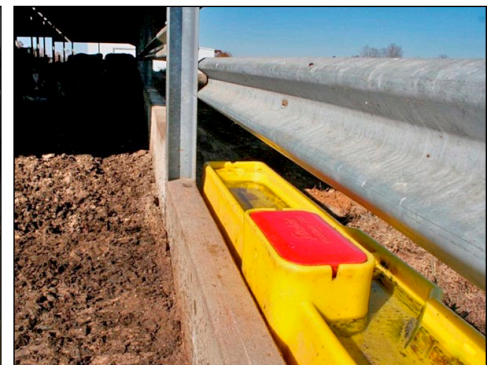

Figure 22. Adequate water access is critical. Most compost bedded pack barns do not meet the recommendations for water space. This system provides cows with adequate water without allowing access from the pack.



Figure 23. When cows can access waterers from the pack, the areas around the water are generally wet and bacteria-laden. The increased moisture from waterers and cow congregation impair compost success.



Figure 24. This barn incorporated a drainage pipe with free-flowing water along the entire length and opposite of the feed alley.

Manure and urine in the feed alley needs to be removed daily and may need to be handled as a liquid, separately from the compost. The liquid manure will require its own manure storage. Another option is to use a slotted floor in the feeding alley with manure storage beneath. Prior to starting construction, producers should consult their state's environmental agency or Extension for details on manure storage structures and application requirements.

Compost Bed Size

A guide for determining a size for a compost bedded pack barn is in Worksheet 1. First, one needs to decide how much space to allocate per animal. In general, the pack area should provide at least 100 square feet of resting space per cow (85 square feet for Jerseys). Pack space per cow needs to be increased 10 square feet for each 25 pounds per day of increased milk production above 50 pounds per day, because these cows will produce more

Worksheet 1. Calculating compost bedded pack barn dimensions.						
Step	Calculation	=	Formula	Example Inputs ^a	=	Example Answer
1	Required Pack Area	=	RC x NC	100 x 100	=	10,000 sq ft
2	Barn Length	=	(MC x NC)/12	(24 x 100)/12	=	200 ft
3	Pack Width	=	RPA/BL	10,000 x 200	=	50 ft
4	Total Barn Width	=	PW + FAW + EW	50 + 12 + 1	=	63 ft
5	Total Barn Area	=	TBW X BL	63 x 200	=	12,600 sq ft
Key: BL = barn length; EW = exterior walls; FAW = feed alley width; MC = manger space/cow; NC = number of cows; PW = pack width; RC = resting space/cow; RPA = required pack area; TBW =total barn width						
^a Recommendations: RC = 100 sq ft/cow, MC = 24 in/row, FAW = 12 ft, EW = 1 ft.						

urine and manure due to more food and water intake. In facilities for special needs cows, producers should provide 125 square feet of resting space.

An overcrowded barn (Figure 25) can result in too much pack moisture, dirty cows, and high somatic cell counts, for these reasons:

- More manure and urine are generated, which causes the pack's moisture level to rise to excessive levels and considerably slows the composting process.
- Physical packing of the bedding material increases, which reduces airflow in the pack.
- The amount of fecal contamination (non-ag Streps and coliforms) in the resting space increases, which can lead to greater incidence of environmental mastitis.

Natural Ventilation

Adequate ventilation is essential. Ventilation removes heat and moisture created by the cows and the composting process. Proper ventilation generally includes natural air movement through the barn, but mechanical ventilation (fans), can also be used to prevent stagnant areas. Ventilation needs will vary between cold and hot temperatures, necessitating ventilation trade-offs (very open in the summer versus open with curtains in the winter). Proper ventilation can improve cows' overall health and immunity by controlling dust and fine particles that may cause respiratory problems, trouble cooling cows in the summer, and issues with drying the pack surface (which helps keep cows clean).

Sidewalls should have at least 12 feet above the retaining wall or outside curb. (Figure 26). A 14 foot height is recommended for barns wider than 40 feet. For example, if a 40 foot wide barn has a 4-foot concrete wall, the total sidewall height should be 16 feet. To maintain adequate natural ventilation under heat-stress conditions, the

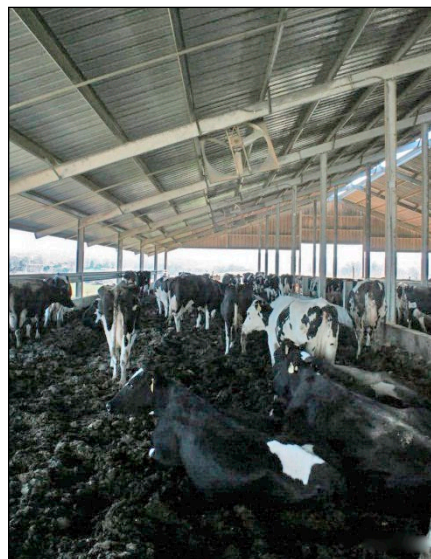

Figure 25. The most common cause of compost bedded pack barn failure is overstocking. Providing less than 100 square feet of resting areas per cow is a recipe for disappointment. The amount of moisture deposited through urine and manure is too much to overcome.



Figure 26. High, open sidewalls maximize cross ventilation. A minimum 12 foot opening should remain between the top of the retaining wall and the bottom of the barn eave.

total open area of a windward barn sidewall plus an endwall is suggested to be at least 7 square feet per cow with the target of 11 square feet per cow. The compost bedded pack barn sidewall area target is 11 square feet per cow since the composting bedding material produces additional heat and moisture. Closed-in barns do not allow for proper cow cooling and pack ventilation (Figure 27).

Eave overhangs should be equal to one-third of the height of the sidewall to minimize rain from reaching the pack. Gutters will reduce runoff from blowing into the pack and creating wet areas (Figures 28 and 29).

Sidewall curtains help minimize the effects of winter winds and inclement weather on compost temperatures (Figure 30). Excessive winter ventilation from open sidewalls increases compost bed moisture evaporation causing heat loss that may not be replaced by compost heat generation. This perspective is different from windrow composting. Compost beds have a larger surface area to heat generating volume compared to compost windrows.



Figure 27. This barn is too closed in to allow for compost drying and air removal.

The sidewall curtains need to maintain a minimum under eave opening of half of the ridge opening to prevent a barn from becoming a “warm barn” in the winter with high levels of condensation, fog, ammonia, and cow pneumonia. Shades may be beneficial to encourage cow distribution within the pack (Figure 31).

Roof pitch of barns of less than 4:12 will limit the natural ventilation rate per cow, particularly during calm winds (less than 2 mph). Too flat of a roof for a wide barn limits the natural ventilation rate and can easily create pockets of warm, moist air. This is a greater issue when warm, moist air is trapped against cold roof surfaces during the winter.

East-west barn orientation takes advantage of prevailing southerly, summer winds and reduces the amount of late afternoon sunlight entering the barn. This orientation also minimizes the time that sunlight bears down on cows within the pack and feed alley. Prevailing winds can be regional or site specific due to the local terrain and barn position within the landscape. Under these situations, the barn should ideally be oriented so the prevailing summer wind is perpendicular to the longitudinal sidewall to allow for adequate ventilation. Extending the roof eave may be required to reduce afternoon sunlight from entering the barn.

A continuous ridge vent opening of at least 3 inches for each 10 feet of roof width is recommended, with a minimum opening of 12 inches for barn widths of less than 40 feet. Air flows into the barn through the windward sidewalls and is exhausted through the ridge vent and the leeward wall opening. Ridge vents are generally more effective if the prevailing winds are perpendicular to the ridgeline. An overshoot (half monitor) ridge opening should face away from the winter prevailing winds.

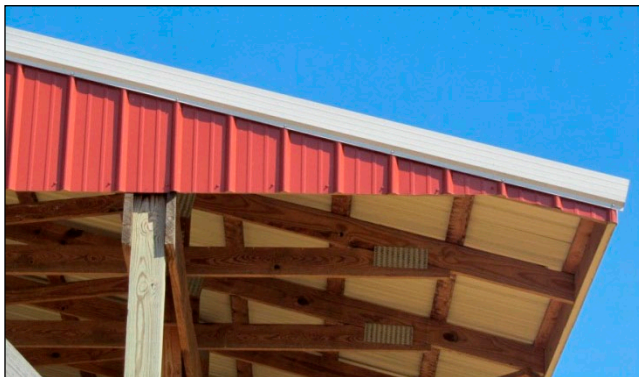
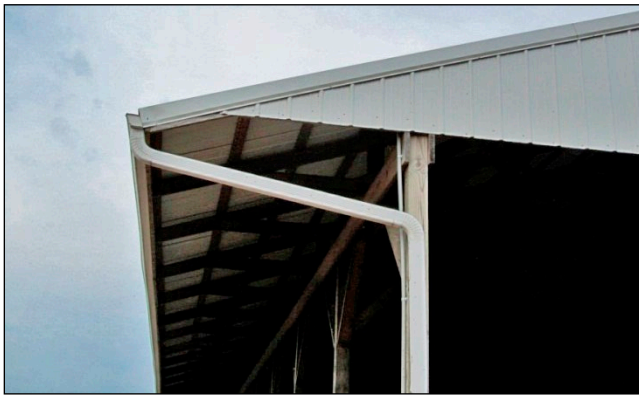
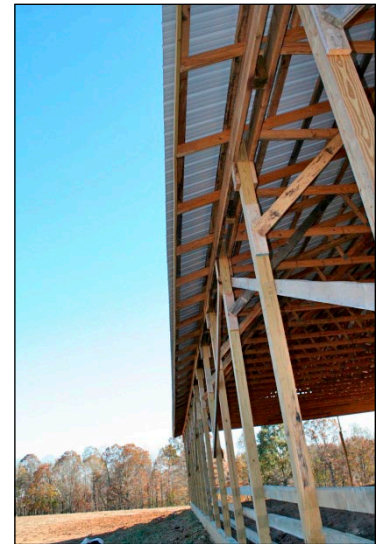

Figure 28. Eave overhangs can help minimize the amount of wind, precipitation, and sunlight entering the barn.



Figure 29. Short eave overhangs increase the likelihood of precipitation entering the pack and creating wet areas.



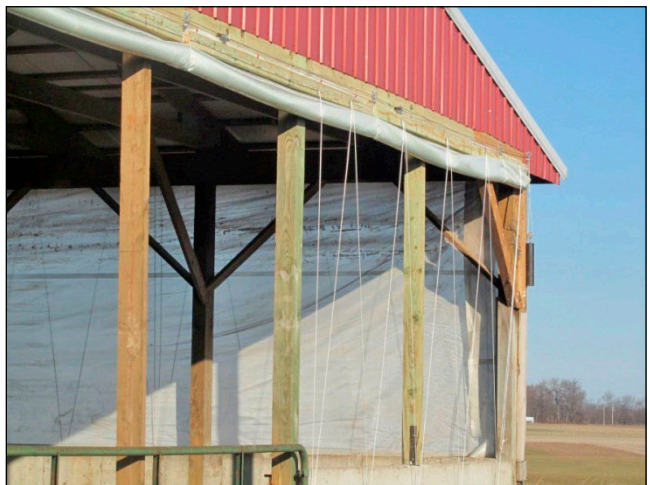

Figure 30. Cold winds blowing across the pack quickly remove the heat needed for composting. Thus, curtains are recommended in the winter. Curtains should be placed at least on the side with predominant winds.

Alternate ridge opening designs can be found in Penn State's publication, Ridge Openings for Naturally Ventilated Dairy Shelters. These designs address concerns about precipitation entering the barn through the ridge opening. Alternative ridge designs along with their advantages and disadvantages are outlined in Figures 32 through 40. The barn site may dictate a different orientation due to terrain, cost of site preparation, or



Figure 31. Shade cloth may help with cow distribution, particularly in barns with a north-south orientation. The shade should not block airflow.



Figure 32. An open ridge vent with an upstand provides maximum air removal with minimal chance of precipitation entering the building.

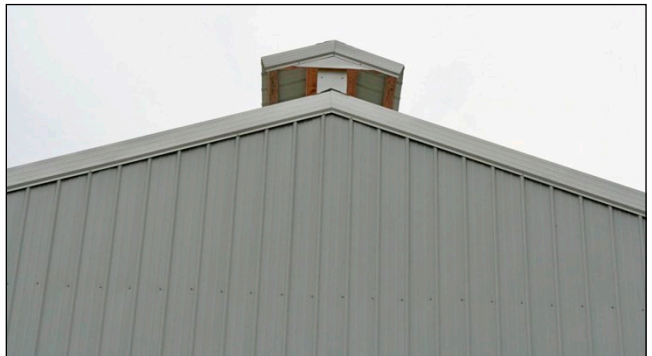

Figure 33. A ridge vent with a cap provides nearly as much air removal as the upstand with less chance of precipitation entering the barn. This design removes more air from the barn regardless of wind direction. Though this ridge vent may cost more than the overshoot design, the benefits to the pack and cow performance easily outweigh the cost over the barn's lifetime.



Figure 34. This uniquely designed barn takes advantage of the most important principles for ventilation. However, the completely enclosed end attached to the milking parlor may limit airflow, and the overhangs are too short.

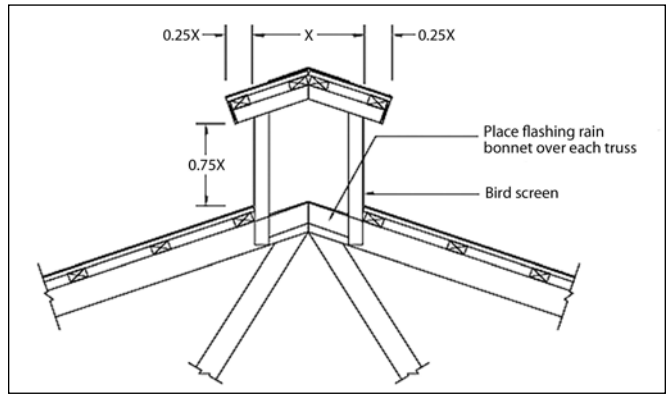

Figure 35. Recommended design of a ridge vent with a cap. Three inches of opening (X) for every 10 feet of building width (minimum 12-inch opening).



Figure 36. These designs share all the features of the first design except for the open ridge. These use an overshoot roof with an opening large enough to allow air removal from the top of the barn. The disadvantage to these is that when the wind blows toward the opening, it may actually push hot or stale air back into the barn in warmer months and cold air in the winter.

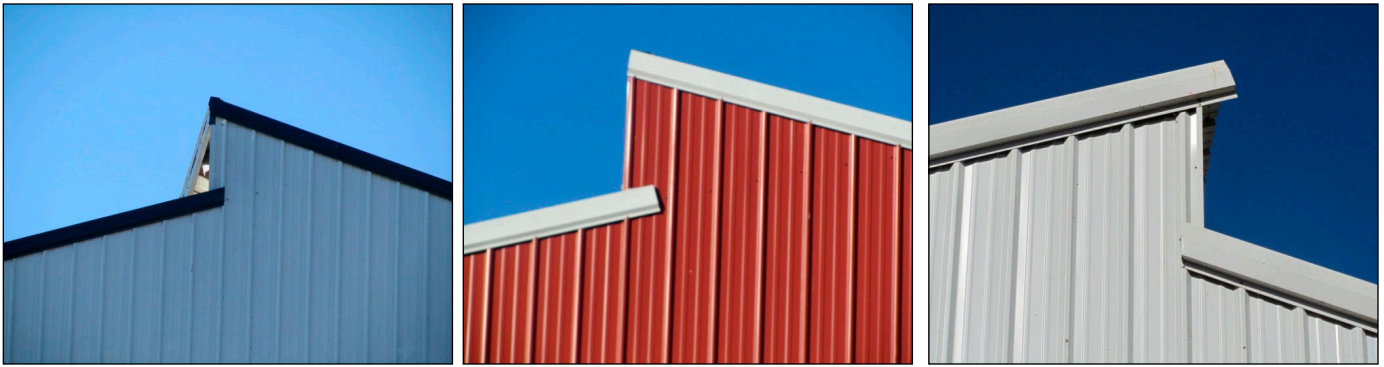

Figure 37. An overshoot roof can provide reasonable air removal when the opening is high enough as depicted in these barns. However, good air removal only occurs when wind moves across the higher side. When wind moves toward the opening, the wind actually forces air back into the barn. This design is not generally recommended.

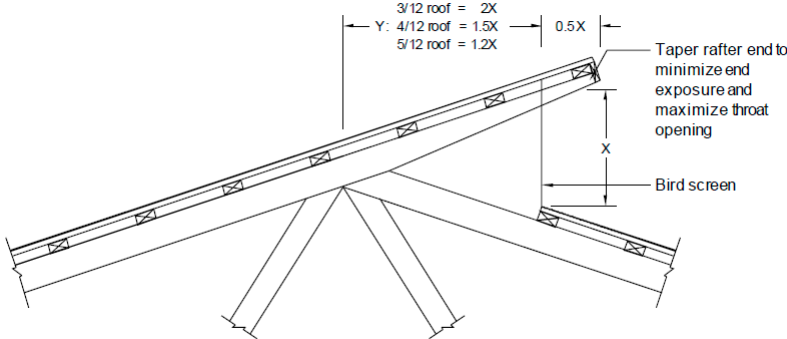

Figure 38. Design of an overshoot ridge. 3 inches of opening (x) for every 10 feet of building width (minimum 12 inches). This design is not preferred.



Figure 39. When the opening of the overshoot ridge is too narrow, the design restricts air removal from the top of the barn and is not generally recommend.

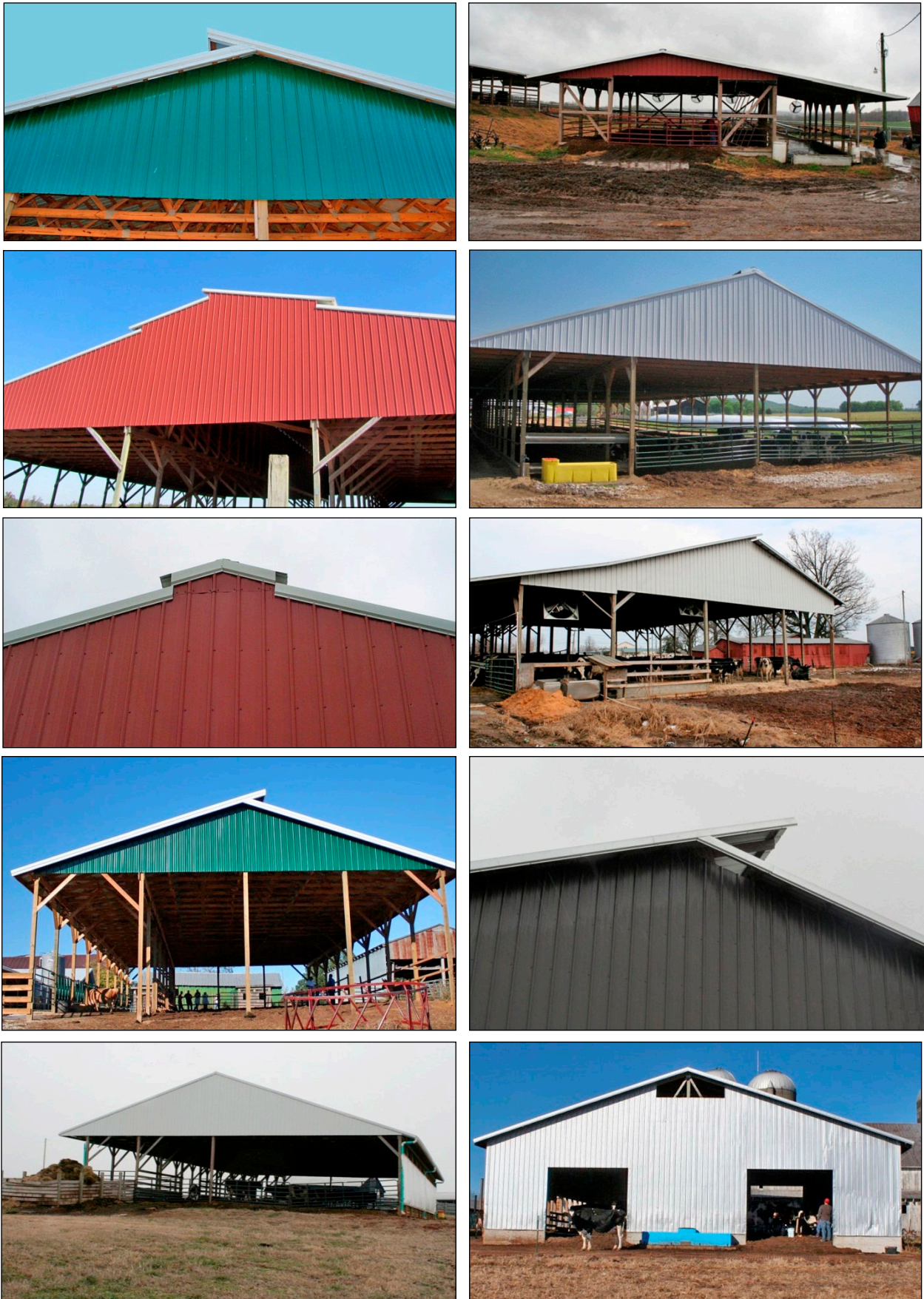

Figure 40. Each of these barns suffers from the same design flaw. In each case, the ridge opening restricts air removal from the top of the barn.

other buildings. The disadvantages of barn orientation may be overcome with floor design, eave extension to reduce sunlight penetration, and mechanical ventilation to overcome reduced natural ventilation.

Circulation Fans

Circulation fans (ceiling or big box) are recommended to help keep the pack dry and ensure adequate air speeds

throughout the barn (Figure 41). Many farms have installed high volume/low speed ceiling fans in their compost bedded pack barns, and these appear to work well (Figure 42). When installing fans, it is important to ensure that there is enough clearance for tillage equipment to work underneath them at maximum pack depth and that fan blades do not damage barn trusses.



Figure 41. Properly positioned fans help cool cows and dry bedding material. They should be placed to supplement, not fight, natural airflow. Follow manufacturer recommendations for spacing and placement.

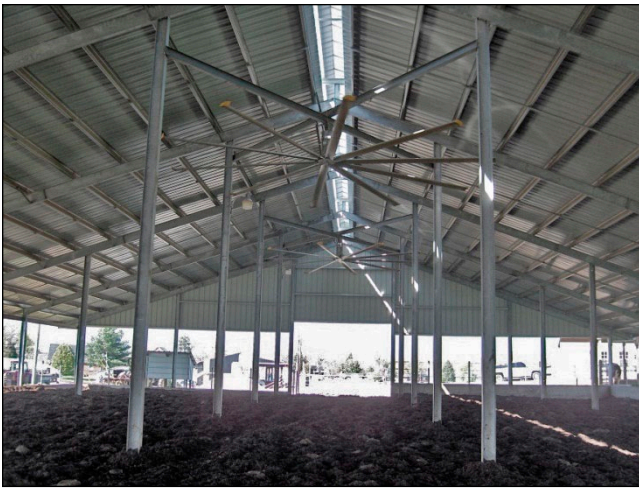

Figure 42. High volume, low speed fans have been added to many compost bedded pack barns. These fans distribute air well across a wide area.

Without circulation fans in the barn, cows may congregate in areas where natural airflow is higher during heat stress conditions (Figure 43). A Cornell University study reported that cows congregated in the center of a barn when temperatures exceeded 80°F. Animals congregating in one area leads to excessive manure and urine accumulation and ineffective composting due to high moisture.

The Composting Process

Composting relies on microorganisms to break down organic matter and produce carbon dioxide, water, and heat. In a compost bedded pack barn, manure, urine, and the added bedding provide the essential nutrients (carbon, nitrogen, moisture, and microorganisms) needed for the composting process.

The continuous introduction and balance of oxygen, carbon, and nitrogen and moisture control are required for success. In a compost bedded pack barn, the oxygen comes from stirring the bedding and from the air that diffuses into the bedding surface. The bedding surface should be fluffy to encourage air infiltration. With balanced proportions, microorganisms will thrive and produce sufficient heat to dry the pack and continue the composting process. This may result in reduction of pathogens, fly larvae, and weed seeds. When the compost pack is working well, the pack surface will appear dry and fluffy (Figure 44). When the pack is not working well, the surface will appear wet and chunky (Figure 45).

The pack's temperature provides a good indication of the level of microbial activity. Temperatures near the surface of the pack are closer to the air temperature,

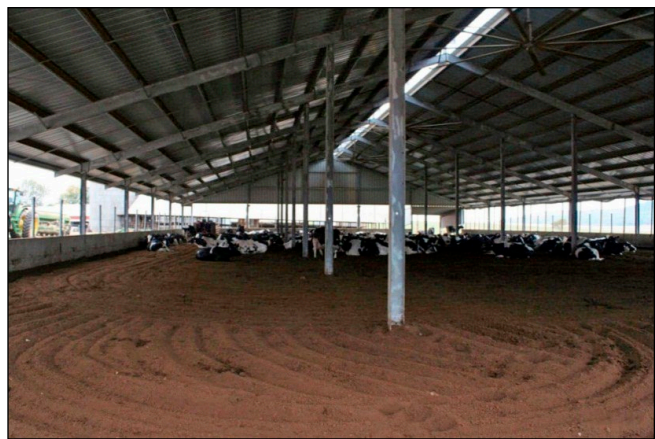

Figure 43. When too few fans are used, dead spots, with little air flow, will result. Cows will not rest in these areas, instead bunching or congregating where it is cooler. This increases heat stress and causes excessively wet and dry areas, impairing compost performance.

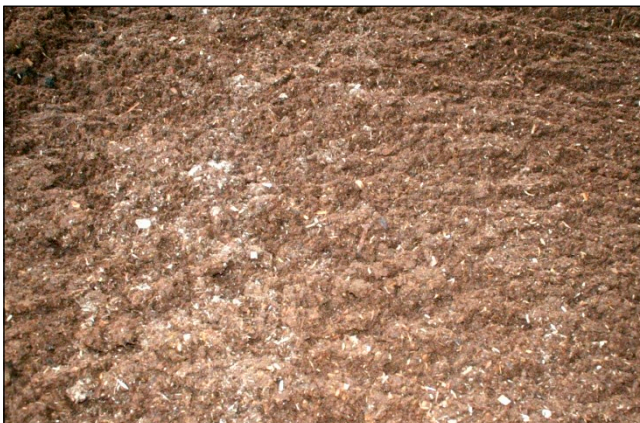

Figure 44. These pictures are examples of properly functioning composting processes. The material is dry and fluffy.



Figure 45. These photos represent compost packs with too much moisture. Notice the clumps of material, the lack of uniformity, and the observable moisture.

because moisture, evaporation, and air movement dissipate heat. However, the bedding surface-temperature under a resting cow will rise. Producers should measure pack temperatures at about 6 to 12 inches below the bedding surface with a long cooking thermometer. The ideal pack temperature is between 110 and 140°F (Figures 46 and 47).

If a thermometer is not available, producers can feel the material (at 12 inches beneath the surface) with their bare hands. If the pack is almost too hot to touch, the temperature is likely high enough (more than 110°F). Particularly in the morning, compost that is heating properly may even produce steam (Figure 48).

When temperatures exceed 150°F, surface temperatures may increase to the point where it is uncomfortable for cows to lie on the pack. A high temperature

indicates that organic materials are rapidly breaking down, and it is likely that beneficial bacteria are being killed. When the temperature is lower, the composting process is too slow. Common reasons for a slow composting process include inadequate oxygen from stirring, too much moisture, or high heat loss during the winter.

Manure, urine, and microbial activity produce moisture.

Ideally, moisture content should be between 45 and 55 percent, but producers can still have significant success if it is between 40 and 60 percent. When moisture is too



Figure 47. A dedicated, easily accessible thermometer is recommended.



A. Example of compost heating well with the appropriate temperature and dry material.



B. Example of compost heating well with high temperature and dry material.



B. Example of compost that is too wet with insufficient temperature.



C. Example of compost that is too dry with insufficient temperature.

Figure 46. Frequent measurement of temperature is important for monitoring compost success.



Figure 48. Particularly in the morning, compost that is heating properly may produce steam.

low, microbes will not have enough water, and the compost will be too cool, resulting in a compost rate that is too slow. If the moisture level is too high, the pack will lack oxygen and the rate of microbial decomposition, composting, and heat generation will be too slow.

As a simple moisture check, producers can grab a handful of bedding and squeeze it. If water comes out or droplets drip from or appear on the surface, the pack is too wet. This is a sign that new dry bedding should be added to the pack. If one cannot form a ball, the pack is too dry. This condition may actually occur when bedding is added too often.

Generally, temperatures are higher when the pack is fluffy because air promotes microbial activity. When the pack is compacted and has excessive moisture, you will see reduced temperatures. Moreover, excessive moisture will make the bedding and manure more readily stick to the cow's hide and udder.

Excessively high temperatures in the compost bed (more than 150°F) occur when there is high microbial activity due to the presence of easily digestible organic matter and moisture is near the low end of the optimal range. Under these conditions, the pack does not have enough water for evaporative cooling. Lack of water may occur when cow density is low, when air movement dries the pack more quickly, or in warm, dry weather.

Ideally, the C: N ratio for a peak composting rate needs to be between 25:1 and 30:1. New bedding material, besides absorbing water, will also aid in achieving this ratio. If you can smell ammonia in the barn, the C: N ratio is likely below 25:1.

Keys to Barn Management

As with any facility, the success of a compost bedded pack barn hinges largely on how well it is managed. Maintaining proper aeration and stocking density are essential. Frequent and uniform stirring helps blend the materials together and promotes a successful composting process. The result is better heating and decomposition of organic material.

Compost Start-up

Compost bed start-up requires 1 foot of bedding to be applied to the barn floor. Depending on barn size, cow numbers, and pack area, several semi-loads of sawdust may be required to start the pack. Add enough sawdust so that the mixing equipment does not touch the barn floor. Producers should start a new bed when four to six weeks of weather with highs above 50°F are expected. Ideally, the new compost's heat generation rate should peak before the arrival of freezing temperatures. Not achieving an actively composting bed going into winter may result in low heat production that cannot replenish lost heat and poor bed performance results throughout the season.

Compost Cleanout

The bedding area is generally removed in the fall, and usually applied to the land. Some producers also clean the packs in the spring to retain the maximum amount of nitrogen for their crops. The pack depth may reach 4 feet before cleaning, depending on the sawdust used and composting intensity. Most producers keep 6 to 12 inches of old material to help start microbial activity in the new pack. If possible, producers should conserve the top layer of the old compost bed. This has the most active, acclimated microorganisms to continue the composting process in the new bed. Some innovative producers continue composting by stockpiling compost material after the pack is cleaned. They turn this material to accelerate drying and then reintroduce this dry product into the pack along with new sawdust. This stretches the sawdust supply and jump-starts the composting process. Compost samples should be analyzed for nutrient value and recorded for manure management plans. Alternatively, the bedding may be removed from the barn, managed to produce finished compost, and sold.

Compost Bed Stirring/Aeration

Uniform stirring and mixing provide a clean, soft, dry surface upon which the cows lie. Aerate the compost bed

to a depth of at least 12 inches. Periodic deep stirring, up to 18 inches, with a chisel plow reduces the amount of bedding needed and increases pack temperatures. Some producers plow the pack twice during each stirring, both lengthwise and crosswise, to further increase aeration. Stir the compost during every milking, while cows are out of the barn. Not only is it easier, but this practice minimizes the chances of the dust causing respiratory issues for the cows. The person doing the stirring should consider wearing a mask to avoid respiratory problems. If possible, cows should be kept off the pack for at least an hour to allow the top layer of bedding to dry, especially

during the winter. Running fans after stirring helps dry the surface throughout the year. Most producers begin stirring about a day after new sawdust is added to the pack. Additional stirring considerations are presented in Figures 49 through 51.

Equipment

Most producers use a cultivator, tines, or a rotary tiller attached to a skid steer or small tractor (Figures 52 through 55) to stir the compost. It is important to breakup tractor tracks by positioning mixing tools to follow the tires. If heavy equipment is used, wheel tracks will not be broken up. Also, if the pack is too wet, it may become compacted, limiting oxygen and causing lower temperatures (Figure 56). Compaction also leads to higher bed moisture and, thus, inadequate aeration.



Figure 49. Observing steam while stirring is a good sign that the compost is heating. It is important to remember in cold weather that steam may appear even when composting is not occurring.



Figure 50. Stirring in multiple directions or circles increases air infiltration and helps break up lumps.



Figure 51. Too many posts within the barn can make pack stirring difficult.



Figure 52. Most compost bedded packs are tilled twice daily with a field cultivator. Many different types of tillage implements have been used successfully.



Addition of Bedding Material

New bedding (4 to 8 inches) should be added to the pack before the moisture increases to the point where the tight ball is formed. Waiting until bedding starts to stick may be too late. The frequency of adding bedding depends on how much evaporation occurs, the amount of manure and urine produced, season, ambient temperature, and ambient humidity. Generally, new bedding is added every one to six weeks. Some producers add smaller amounts of bedding more often. More bedding may be used during humid or wet weather or if the barn is overcrowded.

Moisture control and twice-daily bed stirring are critical for success. Moisture content should be between 40 and 60 percent. The compost bed can get out of balance if managers do not recognize poor moisture conditions before temperatures start falling. This will cause poor cow hygiene and raise the risk of environmental mastitis. Using the “hand squeeze test” will help managers determine if pack moisture is adequate. If it is not, producers may need to add bedding, lower cow numbers, and increase stirring to improve drying and aeration.

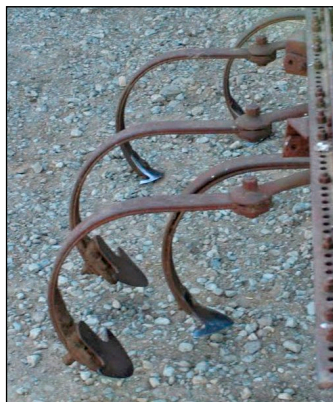

Figure 53. Sweeps or shovels may be added to tillage implement tines to provide more effective stirring. This is a cheap, effective addition to existing implements.



Figure 54. Roto-tillers are helpful to break up clumps of bedding material and maximize oxygen/air infiltration.

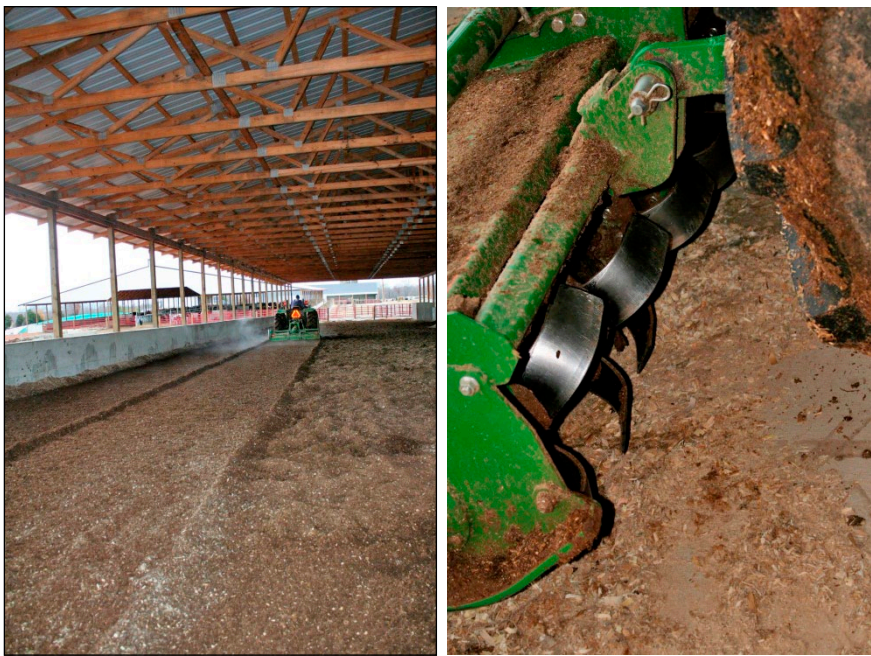

Figure 55. Use of a roto-tiller maximizes oxygen/air infiltration into the pack and provides a uniform mix of material.



Figure 56. Compaction may occur when heavy tractors are used to stir the pack or when implements are pushed rather than pulled. Compaction prevents air infiltration into the pack, which is needed by compost bacteria.

Bedding Material

Researchers and dairy producers suggest dry, fine wood shavings or sawdust, preferably from pine or other softwoods, as the bedding materials of choice in compost bedded pack barns (Figure 57). Chipped wood (Figure 58) is less desirable. Wood chipped with blades has smooth surfaces, which hold less water than sawn or hammer-milled wood with rough surfaces. Wood chipped with flails or hammers may have sharp edges like toothpicks that can injure cows.

Kiln-dried sawdust is preferred, but the pack will perform well as long as sawdust moisture content is less than 18 percent when it is added to the pack. Green sawdust is generally wet and may harbor *Klebsiella* bacteria. If green sawdust is used, a larger amount is needed, because green sawdust has a higher moisture content than kiln-dried. This higher water content reduces the amount of absorption. Cedar should be avoided because it contains oils and organic materials that inhibit microbial activity. Black walnut has been shown to cause laminitis in horses, though there is no research to support this in dairy cattle.

The size of bedding particles is particularly important for regulating microbial activity. At the same time, the high lignin content of these materials provides some resistance to microbial breakdown, which makes it last longer. Kiln-dried sawdust is a fine, coarse material that provides a suitable ratio of surface area to volume, is easy to till, and absorbs liquids well. Alternate bedding materials with large particles do not work well and need

to be finely chopped (Figure 59). In early research studies, finely processed corncobs, soy straw, or flax straw ground through a 0.75-inch screen, have performed well. Such fine materials may be mixed with sawdust to stretch sawdust supply. Long corn stalks, waste hay, and oat, barley, and wheat straw tend to retain too much water, because they slowly dry. Moreover, if the waxy outer surface coating remains on wheat straw, water is slowly absorbed. If you use these alternate bedding materials, you may find it hard to stir and aerate the pack, or you may create a pulp or chunks.

Winter Management

Winter management of compost bedded pack barns is the most challenging and requires the most bedding. Manure piles may freeze during the night and thaw during the day. When pack moisture exceeds acceptable levels, many dairy producers alter their management practices toward more frequent addition of thin layers of fresh bedding to keep cows dry and clean. Bedding



Figure 57. Sawdust from (A) sawn wood, (B) planed wood, and (C) mixture.



Figure 58. Wood chips produced with sharp blades (left) and blunt hammer (right).

usage during the wintertime is generally two to three times more than during the summer. Because sawdust is generally more available in summer months, but needed more in winter months, building a facility for stockpiling sawdust can be helpful for supply management (Figure 60).

Pathogen Levels

Even when the compost process works well, pathogen levels in a compost bedded pack barn are high. Minnesota research showed large numbers (more than 9.1 million cells/cc) of mastitis-causing pathogens on the surface of compost-bedded packs, including coliforms, environmental *Staphylococcus* species, and *Bacillus*. Vaccination of cows with an *E. coli* vaccine may also prove beneficial.

Grouping

In large compost barns, grouping of cows may be necessary. Groups should be limited to 150 cows (Figure 61).

Economic Considerations

Before building a compost bedded pack barn, producers must consider construction costs, along with annual maintenance and bedding costs, and the profitability of a new barn. Building costs vary, because concrete, steel, and wood prices fluctuate. Additional cost factors include whether a producer personally builds the facility and various design options. Per cow construction costs for a compost bedded pack barn are generally lower than for a freestall barn, despite more area required per cow. Less concrete is used, and there is no investment in freestall partitions and bases. An additional cost of the compost bedded pack barn is building an on-farm sawdust storage facility.

While initial investment is lower than a freestall barn, annual maintenance is typically higher. For a 100-cow herd, assume a semi-truckload of sawdust (about 18 tons) is used every two to five weeks. At these rates, bedding costs have ranged from 35 to 85 cents per cow per day. Compost barn managers are also advised to clean shade cloth and ventilation inlets frequently, because of the amount of dust stirred throughout the year.

Also, consider the cost of handling manure. Compost bedded pack barns reduce the amount of manure storage but require equipment to handle both liquid and dry manure. Keep in mind that dry manure can be easier to handle. Furthermore, composting stabilizes the nutrient concentrations of the manure.



Figure 59. Chopped straw (left) will not work as well in a compost bedded pack barn compared to straw run through a hammer mill with a 0.75-inch screen (right).

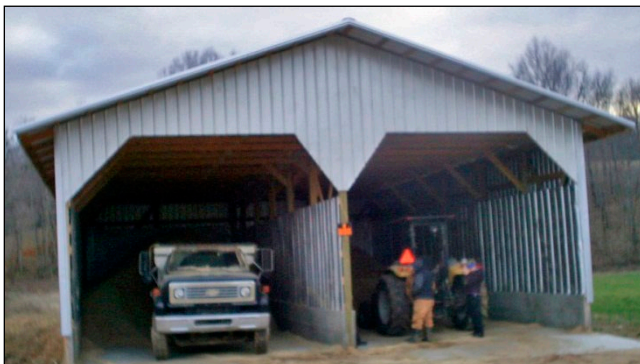

Figure 60. Dedicating a storage area for sawdust supplies helps keep it dry and allows for stockpiling for times of high demand or low supply.

In calculating labor costs, assume that 10 to 15 minutes per 100 cows is required for stirring and scraping the feed alley, which is generally accomplished twice daily during milkings. To offset costs, some producers find a market in which to sell the final compost.

Potential Limitations

The primary limitation for compost bedded pack barns to date has been sawdust availability. These barns require three to four times more bedding than a typical freestall barn. In on-farm experiments, alternative materials have not performed as well. Those considering a installing a compost bedded pack barn, should have a reliable, cost-effective supply of sawdust. Demand for sawdust will go up and prices will continue to rise as more people build these barns and increased demand for sawdust comes from the biofuel, dark fire-cured tobacco, charcoal, and other industries. Producers should consider how sawdust prices affect daily and annual bedding costs.

If the pack is not managed well, the higher risk of exposure to environmental mastitis pathogens can add to production costs.

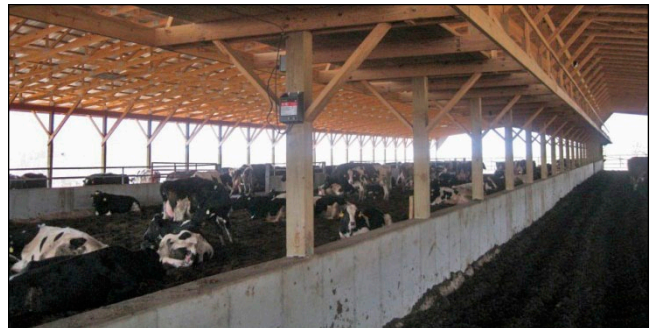

Figure 61. This barn incorporated a concrete barrier to separate the barn into two management groups. Additionally, a catwalk was added to the barn for cow observation.

References

- Alakangas, E. 2010. European Standard for Wood Chips and Hog Fuel. Proceedings Forest Bioenergy 2010. FINBIO Publications 47, pp. 329-340.
- Barberg, A. E., M. I. Endres, and K. A. Janni. 2007a. Compost Dairy Barns in Minnesota: A Descriptive Study. *Appl. Eng. Agric.* 23(2):231.
- Barberg, A. E., M. I. Endres, J. A. Salfer, and J. K. Reneau. 2007b. Performance and Welfare of Dairy Cows in an Alternative Housing System in Minnesota. *J. Dairy Sci.* 90(3):1575-1583.
- Bewley, J.M. and J.L. Taraba. 2009. Compost Bedded Pack Barns in Kentucky. University of Kentucky Cooperative Extension Service Factsheet ID-178.
- Bey, R. and J. Reneau. 2007. Composting Effects on Mastitis Pathogens. In: Proceedings of the National Compost Dairy Barn Conference, June 21-22, 2007, Burnsville, Minnesota. pp. 3-16.
- Endres, M. I. and A. E. Barberg. 2007. Behavior of Dairy Cows in an Alternative Bedded Pack Housing System. *Journal of Dairy Science* 90(9):4192.
- Endres, M.I. and K.A. Janni. 2008. Compost-bedded Pack Barns for Dairy Cows. Accessed: March 3, 2009. Available at: http://www.extension.org/pages/Compost_Bedded_Pack_Barns_for_Dairy_Cows.
- Gay, S.W. 2006. Bedded Pack Dairy Barns. Accessed: 16 March 2009. Publication Number 442-124. Available at: <http://www.ext.vt.edu/pubs/bse/442-124/442-124.html>
- Graves, R.E. and M. Bruggger. 1995. Natural Ventilation for Freestall Barns. Extension Publication G 75. Penn State University, College Park.
- Halbach, T.R. 2007. Compost Basics: "Ball Park" Initial Conditions. In: Proceedings of the National Compost Dairy Barn Conference, June 21-22, 2007, Burnsville, Minnesota. pp. 3-16.
- Janni, K. A., M. I. Endres, J. K. Reneau, and W. Schoper. 2006. Compost Barns: An Alternative Dairy Housing System in Minnesota. Proceedings of the 2006 American Society of Agricultural and Biological Engineers (ASABE) Annual International Meeting, Portland, Oregon. ASABE Paper 64031.
- Janni, K. A., M. I. Endres, J. K. Reneau, and W. W. Schoper. 2007. Compost Dairy Barn Layout and Management Recommendations. *Appl. Eng. Agric.* 23(1):97.
- Kammel, D. 2005. Design and Maintenance of a Bedded Pen (Pack) Housing System. Accessed: March 16, 2009. Available at: <http://www.uwex.edu/ces/cty/marathon/ag/modern/documents/DesignofBedded-PackHousing.pdf>
- Petzen, J., C. Wolfanger, J. Bonhotal, M. Schwarz, T. Terry, N. Youngers. 2009. Case Study: Eagleview Compost Dairy Barn.
- Shane, E.M., M.I. Endres, D.G. Johnson, and J.K. Reneau. 2008. Bedding Options for an Alternative Housing System for Dairy Cows. Abstract W180. American Dairy Science Association Annual Meeting. Indianapolis, Indiana.
- Stowell, R. R., W. G. Bickert and F. V. Nurnberger. 1998. Radiant Heating and Thermal Environment of Metal-Roofed Dairy Barns. In: Proceedings of the Fourth International Dairy Housing Conference, p. 193-200. ASAE, St. Joseph, Michigan 49085.
- Tyson, J. T. 2010. Dairy Heat Abatement System Selection Tool Paper Number: 1008950. 2010 ASABE Annual International Meeting. Pittsburgh, Pennsylvania. June 20 -23.